

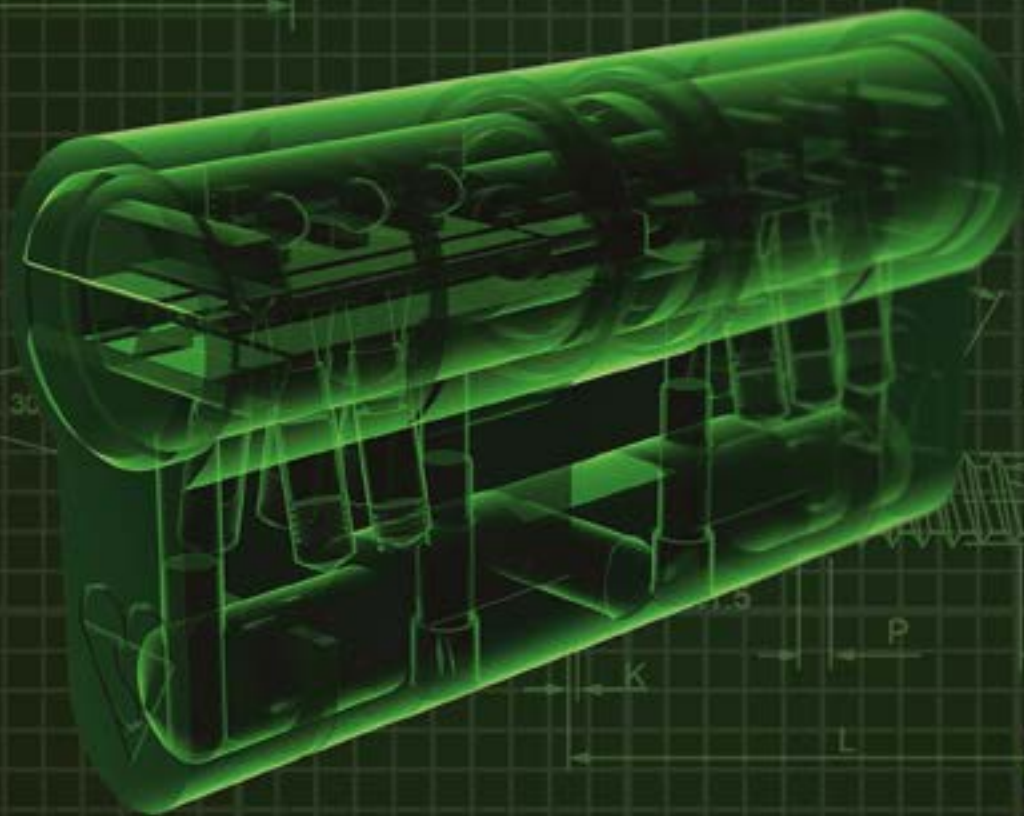





UK FASTENERS

Consumables & Hardware









CONSUMABLES, WINDOW & DOOR HARDWARE PRODUCTS



UK Fasteners part of Till & Whitehead Ltd



HSS DRILL RANGE																	
CODE: DRL1									TIN COATED MEDIUM SERIES FULLY GROUND HSS DRILL DIN338								
DIA (mm)	2.0	2.5	3.0	3.2	3.5	4.0	4.5	4.8	5.0	5.5	6.0	7.0	8.0	10.0			
LENGTH	49mm	57mm	61mm	65mm	70mm	75mm	80mm	86mm	86mm	93mm	93mm	109mm	117mm	133mm			
PACK:	10	10	10	10	10	10	10	10	10	10	10	10	10	5			
CODE: DRL2									TIN COATED LONG SERIES FULLY GROUND HSS DRILL DIN340								
DIA (mm)	2.5	3.0	3.2	3.5	4.0	4.2	4.5	4.8	5.0	5.5	6.0	6.5	7.0	7.2	8.0	10.0	
LENGTH	95mm	100mm	106mm	112mm	119mm	119mm	126mm	132mm	132mm	139mm	139mm	148mm	156mm	156mm	165mm	184mm	
PACK:	10	10	10	10	10	10	10	10	10	10	10	10	10	10	10	5	
CODE: DRL3									HSS JOBBER DRILLS MEDIUM SERIES (BLACK) DIN338								
DIA (mm)	2.0	2.5	3.0	3.2	3.5	4.0	4.5	4.8	5.0	5.5	6.0	6.5	7.0	7.5	8.0	10.0	
LENGTH	49mm	57mm	61mm	65mm	70mm	75mm	80mm	86mm	86mm	93mm	93mm	101mm	109mm	109mm	117mm	133mm	
PACK:	10	10	10	10	10	10	10	10	10	10	10	10	10	10	5	5	
CODE: DRL4									HSS JOBBER DRILLS LONG SERIES (BLACK) DIN340								
DIA (mm)	2.0	2.5	3.0	3.2	3.5	4.0	4.5	4.8	5.0	5.5	6.0	6.5	7.0	7.5	8.0	10.0	
LENGTH	85mm	95mm	100mm	106mm	112mm	119mm	126mm	132mm	132mm	139mm	139mm	148mm	156mm	156mm	165mm	184mm	
PACK:	10	10	10	10	10	10	10	10	10	10	10	10	10	10	5	5	
SDS PLUS DRILLS																	
CODE: DRL5									SDS PLUS MASONRY HAMMER IMPACT DRILL								
DIA (mm)	4.0	5.0	6.0	6.5	7.0	8.0	10.0										
LENGTH	160mm	210mm	160mm	210mm	160mm	210mm	260mm	160mm	210mm	160mm	210mm	260mm	160mm	210mm	260mm		
PACK:	10	10	10	10	10	10	10	10	10	10	10	10	5	5	5		
ALPEN DRILLS - PREMIUM RANGE HIGH PERFORMANCE																	
SDS PLUS DRILLS																	
																	
DIA (mm)	6.0				6.5				6.5								
LENGTH	210mm				210mm				260mm								
PACK:	10				10				10								

* ADDITIONAL SIZES AVAILABLE UPON REQUEST *







DORMER DRILLS - PREMIUM RANGE																	
HSS TIN STRAIGHT SHANK JOBBER DRILL																	
																	
<ul style="list-style-type: none"> HSS TIN COATED JOBBER DRILL FOR GENERAL MACHINING APPLICATIONS UP TO X4 DIAMETER TITANIUM NITRIDE TIP COATING (2.0MM AND ABOVE NOT ONLY MINIMISES WEAR AND INCREASES TOOL LIFE, BUT ALSO ALLOWS INCREASED PERFORMANCE IMPROVED FLUTE GEOMETRY FOR RAPID CHIP EVACUATION FEATURES SELF-CENTRING SPLIT-POINT FOR EXCELLENT POSITIONAL ACCURACY AND HOLE QUALITY MANUFACTURED TO BS328/DIN338 STANDARDS AVAILABLE IN SIZES UP TO 16.0MM 																	
CODE: A002									HSS MEDIUM DRILL TITANIUM NITRIDE COATED DIN338								
DIA (mm)	2.0	2.1	2.4	2.5	3.0	3.1	3.2	3.5	4.0	4.1	4.2	4.3	4.5	5.0	5.1	5.2	5.4
LENGTH	49mm	49mm	57mm	57mm	61mm	65mm	65mm	70mm	75mm	75mm	75mm	80mm	80mm	86mm	86mm	86mm	93mm
PACK:	10	10	10	10	10	10	10	10	10	10	10	10	10	10	10	10	10
DIA (mm)	5.5	6.0	6.5	7.0	7.2	7.5	8.0	8.2	9.0	9.2	9.5	10.0	11.0	12.0	13.0	15.0	
LENGTH	93mm	93mm	101mm	109mm	109mm	109mm	117mm	117mm	125mm	125mm	125mm	133mm	142mm	151mm	151mm	169mm	
PACK:	10	10	10	10	10	10	10	10	10	10	10	10	5	5	5	EACH	
HSS STRAIGHT SHANK LONG SERIES DRILL																	
																	
<ul style="list-style-type: none"> HSS LONG SERIES DRILL FOR GENERAL MACHINING APPLICATIONS UP TO X6 DIAMETER IDEAL FOR DEEPER HOLE DRILLING OR WHERE A SLIGHTLY LONGER REACH IS REQUIRED STEAM TEMPERED FINISH FOR IMPROVED WEAR RESISTANCE MANUFACTURED TO DIN340 STANDARDS 																	
CODE: A110									HSS LONG SERIES DRILL DIN340								
DIA (mm)	2.5	3.0	3.2	3.5	4.0	4.2	4.5	4.8	5.0	5.2	5.5	6.0	6.5	7.0	7.2	8.0	10.0
LENGTH	95mm	100mm	106mm	112mm	119mm	119mm	126mm	132mm	132mm	132mm	139mm	139mm	148mm	156mm	156mm	165mm	184mm
PACK:	10	10	10	10	10	10	10	10	10	10	10	10	10	5	5	5	5
HSS STRAIGHT SHANK JOBBER DRILL																	
																	
<ul style="list-style-type: none"> HSS JOBBER DRILL FOR GENERAL MACHINING APPLICATIONS UP TO X4 DIAMETER. SILVER RING FOR EASY TOOL IDENTIFICATION AND YOUR GUARANTEE OF DORMER QUALITY 118° POINT ANGLE STEAM TEMPERED FINISH FOR IMPROVED WEAR RESISTANCE MANUFACTURED TO BS328/DIN338 STANDARDS AVAILABLE IN SIZES UP TO 20.0MM 																	
CODE: A100									HSS MEDIUM DRILL STEAM TEMPERED BLACK DIN338								
DIA (mm)	3.0	3.5	3.8	4.0	4.5	5.0	5.5	6.0									
LENGTH	61mm	70mm	75mm	75mm	80mm	86mm	93mm	93mm									
PACK:	10	10	10	10	10	10	10	10									
* ADDITIONAL SIZES AVAILABLE UPON REQUEST *																	
ROUTER CUTTERS AVAILABLE TO ORDER																	
PRODUCT	DESCRIPTION											DIMENSIONS					
	ROUTER CUTTER WITH RELIEF											VARIOUS					
	ROUTER CUTTER WITHOUT RELIEF											VARIOUS					

SCREW DRIVER BITS & ACCESSORIES

DRIVER BIT HOLDERS

PRODUCT	DESCRIPTION	LENGTHS (mm)	PACK QTY
	MAGNETIC DRIVER BIT HOLDER WITH RETAINING RING (1/4")	60	10
	SLIMLINE QUICK RELEASE BIT HOLDER GREEN (1/4")	65	1
	MAGLEV QUICK RELEASE BIT HOLDER GREEN. (1/4")	65	1







DRIVER BIT RANGE

PH		LENGTHS (mm)					
		25	49	70	89	102	152
PH1 (PHILLIPS No1)		•	•				
PH2 (PHILLIPS No2)		•	•	•	•	•	•
PH3 (PHILLIPS No3)		•	•				
PH		LENGTHS (mm)					
		25	49	70	89	102	152
PH2 (PHILLIPS No2) ACR (Ribbed)		•	•				
PH		LENGTHS (mm)					
		25	49	70	89	102	152
PH2 (PHILLIPS No2) ACR (Reduced Head)		•					
PZ		LENGTHS (mm)					
		25	49	70	89	102	152
PZ1 (POZI No1)		•	•				
PZ2 (POZI No2)		•	•	•	•	•	•
PZ3 (POZI No3)		•	•	•	•		
SQ		LENGTHS (mm)					
		25	49	70	89	102	152
SQ1 (SQUARE DRIVE BIT)		•	•				
T30		LENGTHS (mm)					
		25	49	70	89	102	152
T30 6 LOBE TORX (TO SUIT 9000 SERIES CONCRETE SCREWS)		•	•				

WERA TOOLS RANGE

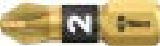

- COATED WITH MINUTE DIAMOND PARTICLES
- DRAMATICALLY REDUCED DANGER OF SLIPPING
- SAFER SCREWDRIVING ON SENSITIVE SURFACES
- LESS CONTACT PRESSURE NEEDED FOR DRIVING
- LESS WEAR TO BITS & SCREW
- QUICKER FASTENING TIMES







PRODUCT	PART NUMBER	DESCRIPTION	PACK QTY
PH 	056402	PH2 x 25mm PHILIPS NO.2 DIAMOND COATED DRIVER BIT	10
PH 	059532	PH2 x 50mm PHILIPS NO.2 DIAMOND COATED DRIVER BIT	10
PZ 	056702	PZ2 X 25mm POZI NO.2 DIAMOND COATED DRIVER BIT	5
PH  PZ 	0505775001	PH 2 x 25mm PHILIPS No. 2 bit box. 20 pieces.	20
	05057761001	PZ 2 x 25mm POZI No. 2 bit box. 20 pieces.	20
	889/4/1	K RAPIDAPTER UNIVERSAL BIT HOLDER 1/4"	5

TEFLON® COATED FABRIC

PRODUCT	DESCRIPTION	SIZE
		1meter x 5meter Roll
	PREMIUM Silver self-adhesive Teflon 05-115/85	•
	STANDARD Silver self-adhesive Teflon 04-102/85	•

PPE & ACCESSORIES

THE IMAGES & DESCRIPTIONS BELOW ARE REPRESENTATIVE OF THE VAST ARRAY OF PRODUCTS AVAILABLE FROM WITHIN THIS RANGE. PLEASE CONTACT US FOR QUOTATION ON ANY PRODUCTS NOT SHOWN OR ANY SPECIFIC REQUIREMENTS YOU MAY HAVE.

PRODUCT	DESCRIPTION	SIZES			
LIGHTWEIGHT POLYURETHANE COATED GLOVE					
	EXCELLENT DEXTERITY & GRIP WITH IMPROVED MECHANICAL PROTECTION. AVAILABLE IN BLACK OR GREY	SMALL	MEDIUM	LARGE	XL
DISPOSABLE GLOVES					
	LATEX OR VINYL GLOVES AVAILABLE / POWDERED OR UNPOWDERED	SMALL	MEDIUM	LARGE	XL
SAFETY GLASSES					
	SAFETY GLASSES - ANTI FOG / ANTI SCRATCH PACK QUANTITY WILL APPLY				
DUST MASKS					
	VENTED MESH CUP MASKS / FOLD FLAT DUST MASKS (P1 / P2 / P3) PACK QUANTITY WILL APPLY				
KNIVES					
	DON CARLOS / STANLEY RETRACTABLE KNIVES / PACKAGING CUTTERS				
SHEARS					
	45 degree X-pert Mitre Shears SK2 Utility blade				
MALLET					
	Thor Glazing Mallet 710 1lb (445gms) NHM 20032				

TOUCH-UP PENS

FULL RANGE OF COLOURS AVAILABLE

A highly pigmented, weather resistant, acrylic based paint touch-up pen, which is ideal for edges and mitre joints. Improved valve technology provides two styles of application.

- Full range of colours available. Get the exact colour you want! Scan the QR code on the next page or give our team the colour details and we will match it for you.
- Bespoke colour match also available. We can have pens made for you, minimum order of only 5 pens!.
- A thinner style pen is also available for use on narrow mitres. Please ask us for details.
- Spare tips are available to buy separately.



DEDICATED PROFILE; SPRAY PAINT



400ml Aerosol spray paint Foil colours, profile whites and lacquers. Bespoke colours available, minimum order of only 3 aerosol cans. Scan the QR code below.

TOUCH-UP PAINT POTS



A pigmented, weather resistant touch-up lacquer applied by brush. Ideal for base work and laminated surfaces. Can be used as an alternative to colour edging pens when there is a larger area to cover. K0240 Touch up Pots.

REPAIR WAXES

A hard and durable wax filler, designed for repairs to areas subject to severe use. Ideal for repairing edge damage as well as fill holes and scratches of m significant damage.

Applies using the range of battery, gas or electric heating irons.



REPAIR KITS – Window Doctor Kit (K0614)



The "Window Doctor Kit" is designed for window installers and allows them to carry out simple on-site repairs to popular Renolit foils. Every window installer should have one!

Comes complete with:

- K0438620 – Battery operated heating iron
- K0161500 – Special applicator
- K042210 – x2 cotton cloths – Size A5
- 4cm Hard wax as below:
Dark Mahogany (K0141114) Dark Oak (K0141143) Black (K01419005) Golden Oak (K014149601) Irish Oak (K014196006) Profile White (K0141) Anthracite Grey (K014178516)

REPAIR KITS – Window Repair Complete Kit (K0670COMP)



The "Complete Window Repair Kit" is designed for window factories and service engineers allowing them to carry out cosmetic repairs reducing the need for expensive and time-consuming remakes.

This kit comes complete with:

- Carry case & foam insert
- Gas heating iron
- Mixed window waxes
- Special applicator
- Special scraper
- Felt pad with abrasive lining
- Cotton cloths
- Cellulose thinners 150ml
- Brass brush
- Paint brush
- Paint palette
- Mixing cups (Pack of 5)
- Mixed touch up pots
- Polishing paste (Bottle 250ml)
- Maintenance lacquer 250ml
- Maintenance sponge
- Wet & Dry single sheets (P1200 grit)
- Aerosol lacquer – Extrusion white.

All the items can be bought separately to replace once used.

UPVC Window Customer care Pack



The Konig UPVC window customer care pack is designed to be used by the homeowner to easily and quickly remedy any accidental cosmetic damage such as scuffs or scratches that may occur to the frames during their lifetime. It contains a water based cleaning fluid and a colour matched touch up bottle along with easy to follow instructions that will disguise any unsightly accidental damage.

Available in all popular colours.

Customer own branding is available please ask for details.

HELP & ADVICE



or visit: www.ukfasteners.co.uk/accessories/Konig

Get perfectly matched Pens, Spray paints and waxes for your profile.

Did you know RAL codes only give you a close match?

For the perfect match scan the QR code and use the Renolite foil codes of your profile.

Help is always on hand!

Please feel free to get in touch for help and advice.

You may also find it useful to know that Konig have made some handy product videos, available to view on YouTube.

You can also scan the QR code for easy access to some useful Konig tutorial videos.

Extrusion White water based cleaner (KOUVCCLEANERWHITE)



The Konig Extrusion White cleaner is a solvent free powerful cleaner that removes dirt and other unwanted residue from extrusion white windows and doors but without damaging the plastic that a solvent based cleaner would. It can be either cloth or sponge applied, simply apply over the entire frame and remove all unwanted residue, then wipe clean with a clean dry cloth. Repeat the process if necessary.

UPVC Composite door cleaner (KOUVCCLEANER)



The Konig UPVC foil and composite door cleaner is a solvent free powerful cleaner that removes dirt and other unwanted residue from foiled windows and composite doors but without damaging the foil gloss effect that a solvent based cleaner would. It can be either cloth or sponge applied, simply apply over the entire frame and remove all unwanted residue, then wipe clean with a clean dry cloth. Repeat the process if necessary.

Universal Maintenance lacquer (K0514)



A multi purpose, quick drying clear lacquer. Suitable for exterior use, providing a water repellent protective coating on PVCU or foiled surfaces. Apply using the maintenance sponge for even application. The heavier the application the higher the sheen level. Available in a 250ml bottle.



PLEASE REQUEST
OUR WINDOW
MASTER
CATALOGUE TO
REVIEW OUR
FULL RANGE



PLEASE REQUEST OUR
AluminiumMASTER
CATALOGUE

QUALITY FASTENERS
FOR ALUMINIUM
WINDOWS & DOORS

TAPES & PROTECTIVE FILMS

DOUBLE SIDED SECURITY GLAZING TAPE

	STANDARD SIZES	BOX QTY
 <p>THIS MEDIUM DENSITY FOAM IS COATED BOTH SIDES WITH A MODIFIED ACRYLIC ADHESIVE WHICH CONFORMS TO THE HIGHEST BS STANDARDS FOR SECURITY GLAZING WITHIN THE WINDOW INDUSTRY.</p> <p>COLOURS: BLACK, WHITE</p> <p>ADHESIVE: ACRYLIC</p>	12mm x 3mm x 25mtr	25
	12mm x 4mm x 20mtr	25
	12mm x 5mm x 15mtr	25
	12mm x 6mm x 15mtr	25
	12mm x 8mm x 10mtr	25

CLOTH (DUCT) TAPE

	STANDARD SIZES	BOX QTY
 <p>AN EXCELLENT INSTANT GRAB AND WATERPROOF BACKING MAKES THIS AN IDEAL DUCT TAPE FOR CONTRACTORS THROUGHOUT THE INDUSTRY.</p> <p>COLOURS: SILVER, BLACK, WHITE, RED, BLUE, YELLOW</p> <p>ADHESIVE: RUBBER</p>	19mm x 50mtr	64
	25mm x 50mtr	48
	38mm x 50mtr	32
	50mm x 50mtr	24
	75mm x 50mtr	16
	100mm x 50mtr	12

MASKING TAPE

GENERAL PURPOSE MASKING TAPE 60°C	LOW BAKE MASKING TAPE 80°C	14 DAY MASKING TAPE 60°C	MANY VARIETIES AVAILABLE - CONTACT US FOR MORE DETAILS
			

DOUBLE SIDED TAPE

	STANDARD SIZES	BOX QTY
 <p>MEGABOND DOUBLE SIDED TAPE HAS A THICK EXTREME GRAB ADHESIVE COATED ON A UNIFORM SCRIM THAT ENABES A CLEAN HAND TEAR. THE TAPE IS A POWERFUL BONDING TAPE THAT BONDS VIRTUALLY EVERYTHING TO ANYTHING.</p>	50mm x 10mtr	24

PROTECTION FILMS

CARPET PROTECTION FILM CLEAR 600mm (W) x 100mtr LOW TACK	GLASS PROTECTION FILM BLUE 600mm (W) x 100mtr	HARD FLOOR PROTECTION FILM RED 600mm (W) X 100mtr	SINGLE
			

SANDING DISCS

PRODUCT	DESCRIPTION	GRITS											
		P80	P100	P120	P150	P180	P220	P240	P320	P400	P500	P600	P800

HERMES VELOUR BACKED

	150mm (6") 6 HOLE MEDIUM WEIGHT ALUMINIUM OXIDE	•	•	•	•	•	•	•	•	•	•	•	•	•
	150mm (6") MEDIUM WEIGHT ALUMINIUM OXIDE	•	•	•	•	•	•	•	•	•	•	•	•	•

HERMES ADHESIVE BACKED

	150mm (6") 6 HOLE MEDIUM WEIGHT ALUMINIUM OXIDE	•	•	•	•	•	•	•	•	•	•	•	•	•
	150mm (6") MEDIUM WEIGHT ALUMINIUM OXIDE	•	•	•	•	•	•	•	•	•	•	•	•	•

CUTTING DISCS

PRODUCT	DESCRIPTION	DIAMETER (mm)					
		100	115	125	180	230	300

HERMES - FLEX, CLASSIC CUTTING & GRINDING DISCS

	METAL CUTTING WHEELS FLAT	•	•	•	•	•	•
	METAL CUTTING WHEELS DEPRESSED	•	•	•	•	•	•
	METAL GRINDING DISCS DEPRESSED	•	•	•	•	•	•
	STONE CUTTING WHEELS FLAT	•	•	•	•	•	•
	STONE CUTTING WHEELS DEPRESSED	•	•	•	•	•	•

SOUDAL FIX & FILL RANGE

SILICONE SEALANT

	SILIRUB N - GENERAL PURPOSE LOW MODULUS, NEUTRAL CURE SILICONE SEALANT		SILIRUB LM - HIGH QUALITY, LOW MODULUS, NEUTRAL CURE SILICONE SEALANT
BRILLIANT WHITE / WHITE / CLEAR / TEAK / BROWN / CARAMEL / BLACK		BRILLIANT WHITE / CLEAR / TEAK / BROWN / CARAMEL / BLACK	
	SILIRUB LMN - SUPERIOR QUALITY, LOW MODULUS NEUTRAL CURE SILICONE SEALANT		SILIRUB COLOR - ANY RAL CLASSIC COLOUR CAN BE PRODUCED, LOW MODULUS, NEUTRAL CURE SILICONE
BRILLIANT WHITE / WHITE / CLEAR / TEAK / BROWN / BLACK / CARAMEL BRONZE / GREY / CHARTWELL / CREAM / ANTHRACITE		ANY RAL CLASSIC COLOUR	

	TRANSPARENT LUBRICATING AND ANTI-ADHESIVE SPRAY. REDUCES FRICTION AND PREVENTS WEAR AND TEAR ON MOVING PLASTIC PARTS. 400ML		EXTENSIVE RANGE OF SEALING AND BONDING ADHESIVES AVAILABLE IN SOLVENT BASED AND SOLVENT FREE
	DECORATORS CAULK GENERAL PURPOSE SEALANT AND FILLER. SOLVENT FREE. CAN BE PAINTED OVER AFTER CURING. 300M		SOUDAL REPAIR EXPRESS CEMENT - HIGH SPEED ACRYLIC POLYMER BASED, TEXTURED REPAIR CEMENT. FOR EASY & QUICK REPARATION OF FILLING JOINTS & CRACKS IN CONCRETE
	SUPERGLUE - AVAILABLE IN MEDIUM OR HIGH VISCOSITY (20ML / 50ML)		SOUDAL SUPERGLUE ACTIVATOR - SOLVENT BASED AEROSOL SPRAY ACTIVATOR (200ML / 400ML)
	SOUDAFOAM GAP FILLER GUN FOAM - POLYURETHANE EXPANDING FOAM FILLER		SOUDAFOAM GUNGRADE FIREFOAM - ONE COMPONENT, SELF EXPANDING, READY TO USE POLYURETHANE FOAM. FIRE RATED UP TO 240 MINUTES (EN1366-4)
	SOUDAL GUN & FOAM CLEANER - READY TO USE CLEANING AEROSOL FOR USE ON SOUDAFOAM GUN & SOUDAL FOAMS		SOUDAL SWIPEX WIPES - HEAVY DUTY NON-WOVEN CLEANING WIPES, SUITABLE FOR HANDS & TOOLS
	PROFESSIONAL QUALITY FAST ACTING AEROSOL CLEANER - THAT REMOVES INGRAINED DIRT MARKS AND RESIDUE. EFFECTIVE CLEANING ON WHITE PVCU FRAMES, SILLS, CLADDING, PANELS AND TRIMS.		SOUDAL PVCU CREAM CLEANER - GENERAL PURPOSE, SOLVENT FREE, CREAM CLEANER FOR A SPARKLING FINISH ON PVCU & OTHER MATERIALS
	PROFESSIONAL QUALITY AEROSOL CLEANING AGENT - THAT PROVIDES A SPOTLESS STREAK FREE FINISH.		SOUDAL TISSUE ROLLS - HEAVY DUTY PAPER CLEANING TISSUES. WHITE COLOUR, 2 PLY, TEAR OFF SHEET STYLE. 100% RECYCLED MATERIAL
	SOUDAL 400ML CARTRIDGE GUN COX BRAND - SUITABLE FOR ALL CARTRIDGE APPLIED ADHESIVES, FILLERS & SEALANTS		SOUDAL COMPACT PU FOAM GUN - PROFESSIONAL GRADE POLYURETHANE APPLICATOR GUN FOR USE WITH FOAM GUNS.

THE ABOVE PRODUCTS ARE A REPRESENTATION OF AN EXTENSIVE RANGE AVAILABLE. PLEASE CONTACT US FOR MORE DETAILS

HIGH SECURITY

KM SUPERIOR 1 STAR EURO PROFILE CYLINDER

The Yale KM Superior 1 Star Euro Elite Profile Cylinder has been developed to provide resistance against common cylinder attack methods. This cylinder is British Kitemarked TS007:2014 1 Star security and has been tested to the British Standard BS EN1303:2005. Suitable as a replacement product this cylinder is Secured by Design approved and recommended for use on doors that require a high level of security and attack protection.

SPECIFICATIONS:

- TS007: 2014 1 Star British Kitemarked cylinder
- BSI Kitemark approved - KM532920
- Secured by Design approved
- 10 year guarantee
- 3 keys supplied

FEATURES:

- Anti-Bump, Anti-Pick, Anti-Screw and Anti-Drill protection
- Available in euro single, euro double and euro turn
- Available in Polished Brass and Nickel Plated finish



MAXIMUM SECURITY

PLATINUM 3 STAR EURO PROFILE CYLINDER

The Yale Platinum 3 Star Cylinder is a TS007:2014 3 star Kitemarked Anti-Snap, Bump, Pick and Pull security product which provides superior strength against known cylinder attack methods. The Platinum 3 Star Cylinder has been independently tested by BSI to be awarded the British Kitemarked TS007:2014 3 star accreditation.

SPECIFICATIONS:

- British Kitemarked TS007:2014 3 star
- Tested to the British Standard BS EN1303:2005
- BSI Kitemark approved - KM559658
- Advanced pin tumbler technology
- Superior physical strength
- Secured by Design approved
- 10 year guarantee
- 3 keys supplied



FEATURES:

- Anti-Snap, Anti-Bump, Anti-Pick, Anti-Screw and Anti-Drill protection
- Available in euro single, euro double and euro turn
- Available in Polished Brass and Bright Nickel finish
- Key card identification to easily identify key cutting code
- Flat, horizontal key way with reversible key (doesn't matter which way around you put the key in lock)
- Yale nylon key head for ease of grip and identification



CYLINDER FEATURES COMPARISON

PLATINUM 3 STAR EURO PROFILE CYLINDER

Features		Anti-Screw	Anti-Pick	Anti-Drill	Anti-Bump	Anti-Snap Kite-mark Approved	BSI TS007 1 Star KM Approved	BSI TS007 3 Star KM Approved	Secured by Design Approved	Guarantee
	KM Superior 1 Star	Yes	Yes	Yes	Yes	No	Yes	No	Yes	10 Years
HIGH SECURITY										
	Platinum 3 Star	Yes	Yes	Yes	Yes	Yes	No	Yes	Yes	10 Years
MAXIMUM SECURITY										

STANDARDS EXPLAINED



TS007 is a standard developed in response to concerns over cylinder attacks. The standard is characterised by a 3 star rating system, and can be achieved by combining a 1 star cylinder with a 2 star security door furniture or using a stand alone 3 star cylinder. The Platinum Series Euro Profile Cylinders are approved to TS007 3 stars and do not require any additional security furniture.

SIMON FRAMEVENT HI-FLO & HI-FLO+



FRAME VENTS

*FULL RANGE OF COLOURS AVAILABLE

MANUFACTURED IN THE HIGHEST QUALITY UV STABILISED PVCU, THE SIMON FRAMEVENT HF & HF+ HAVE BEEN SPECIFICALLY DESIGNED TO MAKE IT EASY TO ACHIEVE THE REQUIREMENTS OF APPROVED DOCUMENT F-2021 WHILST STILL MAINTAINING THE SMOOTH, ROUNDED, AESTHETIC SYNONYMOUS OF THE FRAMEVENT RANGE.

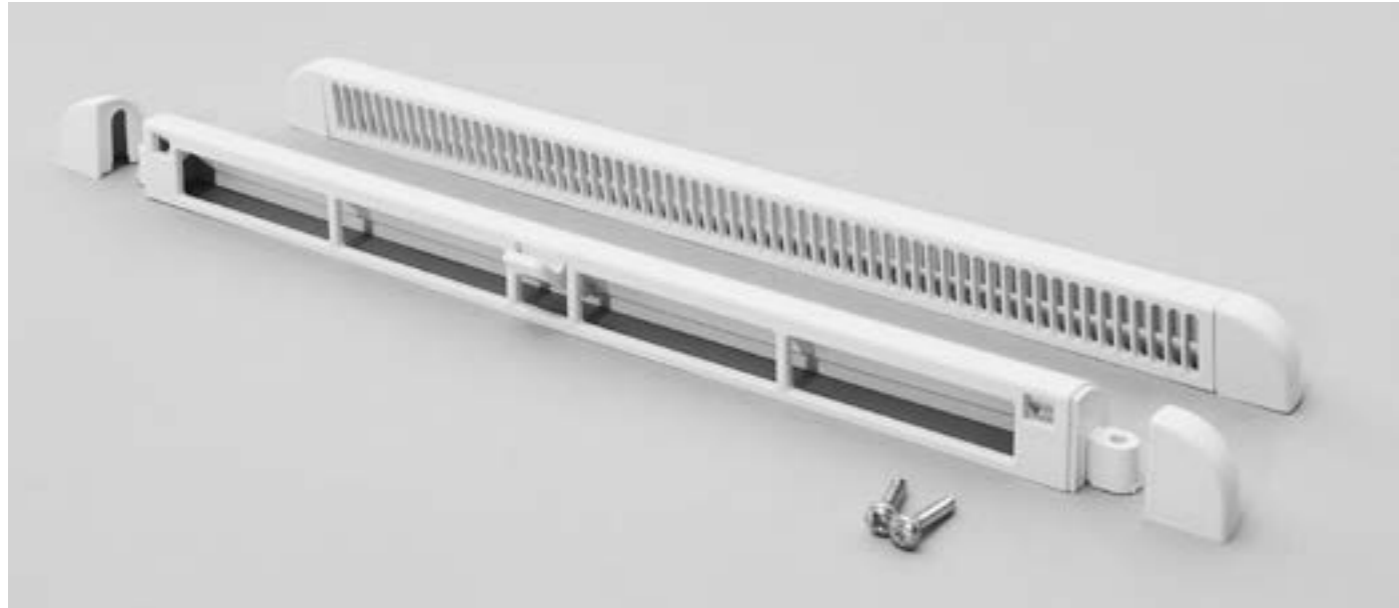

FEATURES & OPTIONS

Features:

- A smooth rounded design
- Snap on, quick fit ends
- Positive open & close action
- Integral flyscreen in external hood
- Suitable for PVCu, timber & aluminium windows

Options:

- Rod control available - for full compliance with Approved Document K 2013
- Can be fitted to give updraught or down-draught
- Dual colours & RAL colours available on request
- Joiner pieces available

Tested in accordance with BS EN 1026:2016 & BS EN 1027:2016 Weather performance

Available in:

	Standard White (RAL 9910)		Bright White (RAL 9016)		Cream (RAL 1015)
	Tan (RAL 8003)		Mahogany Rosewood (RAL 8017)		Black (RAL 9005)
	Grey (RAL 7016)		Irish Oak (RAL 1011)		Chartwell Green (BS 14 C 35)
	Silver Grey (RAL 7001)		Slate Grey (RAL 7015)		Agate Grey (RAL 7038)
	Black Brown (RAL 8022)		Ice Cream White (RAL 9001)		

All the above colours are available as dual on standard white or bright white. 10 year guarantee against colour fade.

*Please consult a RAL chart for accurate colour matching.



Please scan the QR code for all the latest regulations applicable to ventilation airflow.

SIMON FRAMEVENT HI-FLO & HI-FLO+



MODEL DETAILS

TWO MODELS ARE AVAILABLE WITHIN THIS HIGH FLOW RANGE

Framevent HF Length - 415mm Equivalent area as per BS 13141-1:2019 - 4191m ² Box qty. - 50 Slot Size - 2 x (365 x 13mm) + (10mm land)
Framevent HF+ Length - 525mm Equivalent area as per BS 13141-1:2019 - 5205m ² Box qty. - 50 Slot Size - 2 x (230 x 13mm) + (10mm land)

Fitting Instructions:

- Route out the frame with the correct slot size & configuration for the model to be fitted
- Place unit centrally over the slots
- Fix unit in place by using screws provided
- Screw hole centres are 20mm in from each end (40mm off the overall length)

Performance:

- Independently tested to BS EN 13141- 1:2019
- Water tightness of 400pa
- Independently acoustically tested in accordance with BS EN 20140-10:2016, ISO 140-10-2010

Maintenance:

- The Framevent can be cleaned using a damp cloth. The external hood should be brushed lightly to remove dust from the flyscreen area.

- Airflow rates quote are for when fitted in accordance with manufacturer's instructions.

We recommend silicone sealing vents for best results*

ROUTING DETAILS

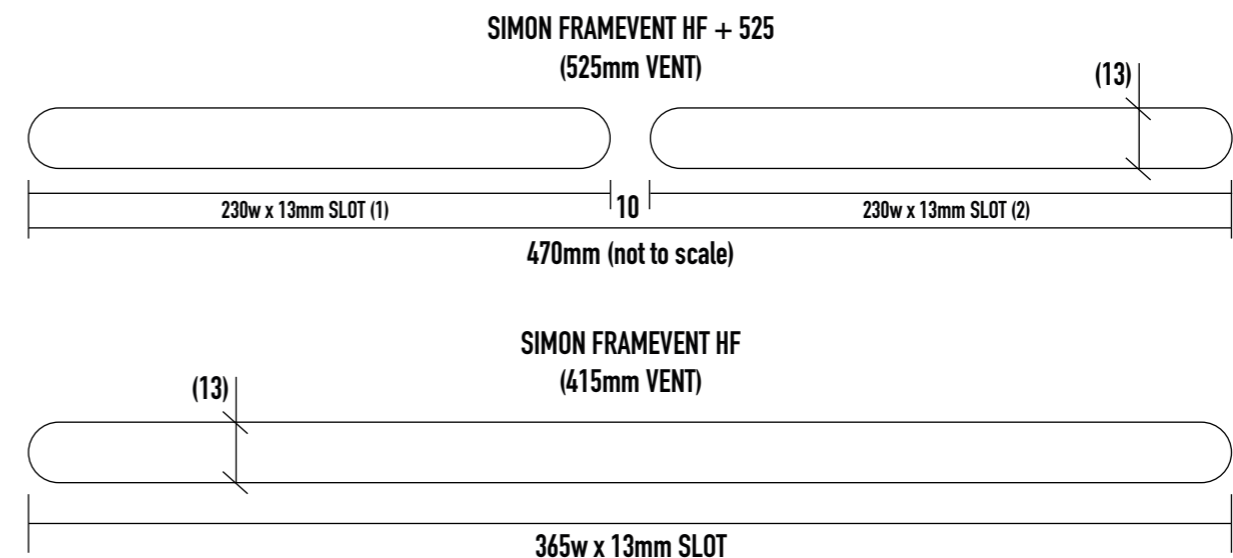

SIMON FRAMEVENT 300 & 400



FRAME VENTS

*FULL RANGE OF COLOURS AVAILABLE

MANUFACTURED IN THE HIGHEST QUALITY UV STABILISED PVCU, THE SIMON FRAMEVENT 300 & 400 HAVE BEEN SPECIFICALLY DESIGNED FOR THE VOLUME MARKET. DURABLE EASY TO FIT AND FULLY TESTED, IT IS IDEAL FOR BOTH TIMBER & PVCU FRAMES AND ITS SLIM, ELEGANT DESIGN MAKES IT A POPULAR CHOICE.

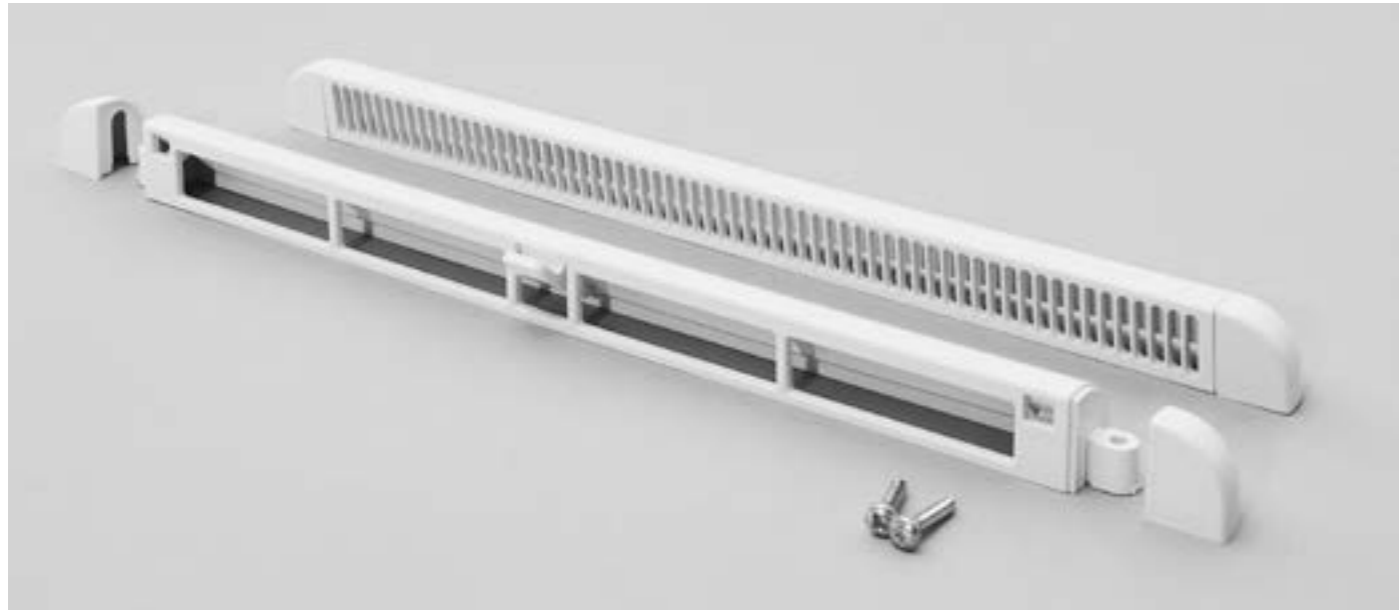

FEATURES & OPTIONS

Features:

- Available in two sizes
- A smooth, rounded design
- Snap on, quick fit ends
- Positive open and close action
- Integral flyscreen in external hood

Options:

- Rod control available - for full compliance with Approved Document K 2013
- Can be fitted to give updraught or down-draught
- Sleeves available - for full compliance with BS7412: 2007 & BS EN 14351-1:2006
- Joiner pieces available

Tested in accordance with BS EN 1026:2016 & BS EN 1027:2016 Weather performance

Available in:

 Standard White (RAL 9910)	 Bright White (RAL 9016)	 Cream (RAL 1015)
 Tan (RAL 8003)	 Mahogany Rosewood (RAL 8017)	 Black (RAL 9005)
 Grey (RAL 7016)	 Irish Oak (RAL 1011)	 Chartwell Green (BS 14 C 35)
 Silver Grey (RAL 7001)	 Slate Grey (RAL 7015)	 Agate Grey (RAL 7038)
 Black Brown (RAL 8022)	 Ice Cream White (RAL 9001)	

All the above colours are available as dual on standard white or bright white. 10 year guarantee against colour fade.

*Please consult a RAL chart for accurate colour matching.



Please scan the QR code for all the latest regulations applicable to ventilation airflow.

SIMON FRAMEVENT 300 & 400



MODEL DETAILS

TWO MODELS ARE AVAILABLE WITHIN THIS FRAMEVENT RANGE.

Framevent 300 Length - 300mm Equivalent area as per BS 13141-1:2019 - 2328m ² Box qty. - 50 Slot Size - 260 x 13mm	Framevent 400 Length - 400mm Equivalent area as per BS 13141-1:2019 - 3180m ² Box qty. - 50 Slot Size - 365 x 13mm
--	--

Performance:

- Independently tested to BS EN 13141- 1:2019
- Water tightness of 400pa
- Independently acoustically tested in accordance with BS EN 20140-10:1992, ISO 140-10-1991

- Airflow rates quote are for when fitted in accordance with manufacturer's instructions. We recommend silicone sealing vents for best results*

ROUTING DETAILS

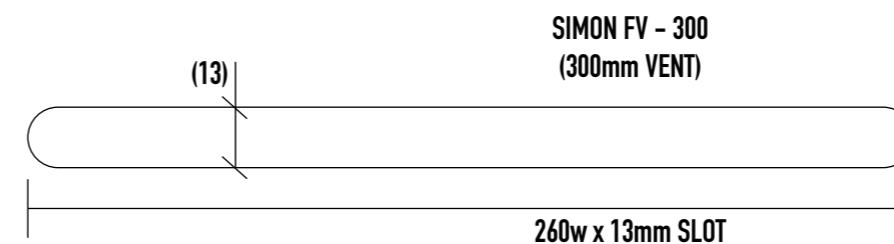
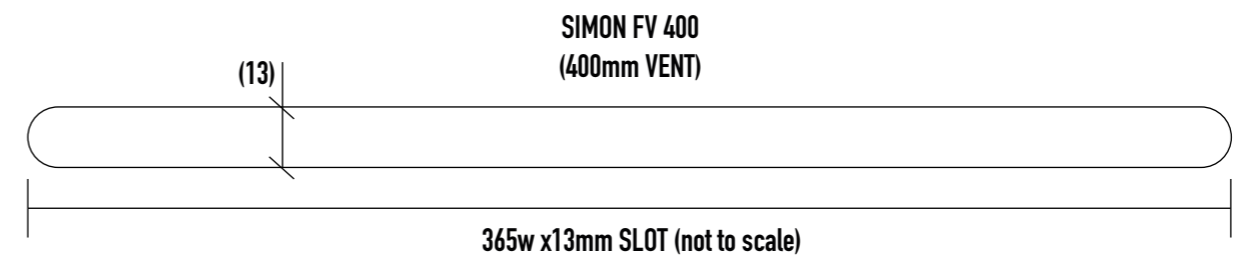



GROOVE

TORX T30 RECESS



UK FASTENERS



UK Fasteners part of Till & Whitehead Ltd

Sterling House, Moreton Road, Longborough,
Moreton-in-Marsh GL56 0QJ
Tel: 01242 577077 Fax: 01242 577078
Email: sales@ukfasteners.co.uk
Website: www.ukfasteners.co.uk

Reg Office: Till & Whitehead Ltd
Eadon House, 2 Lonsdale Road, Bolton BL1 4PW
Reg Number: 46963

REVISION 2 E&OE